











Trailer mounted lift TM15GT

Trailer mounted lift TM15GT

STANDARD EQUIPMENT

- Articulated telescopic boom with flyjib
- 1.3m Flyjib
- Auto platform level with 3 auto adjust
- Alu basket with hand guard rail and tool tray
- Proportional electro-hydraulic controls by fingertip joysticks
- Ground and platform controls
- Ground pressure sensors on all outrigger plates with audible and visible alarms
- Chassis level sensor 1° with accoustic alarm
- Hourmeter
- 230V outlet in the basket
- Manual recovery with hand pump
- Platform rotator
- Colour of the machine: RAL3002 (red).

SPECIFICATIONS

	Working Height	15,6 m
	Platform Height	13,6 m
	Horizontal Reach (220kg)	8,1 m
	Platform Capacity	220 kg
	Slewing	355°
	Flyjib	1.3 m
	Platform dimensions	1,2x0,8x1,1 m
	Platform rotator	2x45°
	Transport length (A)	ca. 6,2 m
	Transport width (B)	1,64 m
	Transport height	ca. 2,05 m
	Total weight: (230V, Honda, wheel assist)	1850 kg
	Total weight: (battery 24VDC, wheel assist)	1850 kg
	Outrigger footprint (D)	3,7 m
	Outrigger plate outer edge	3,7 m
	Gradeability	8%
	Max. towing speed	80 km/h
	Brake	Overrun Brakes with Gas Spring
	Tyres	215 R 14 C

OPTIONS

- Auto chassis level
- Custom colour
- Dual-Power source 230V & Honda
- Batterie Power 24V 225Ah
- On-board 230V Generator 5KV Honda EM5500
- G.R.P. basket with tool tray (2 person)
- Outrigger plate pads

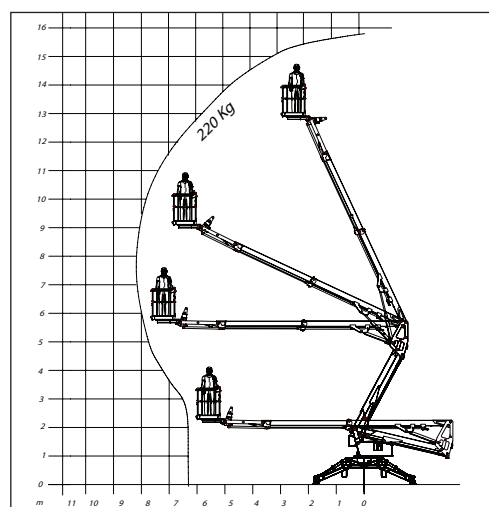
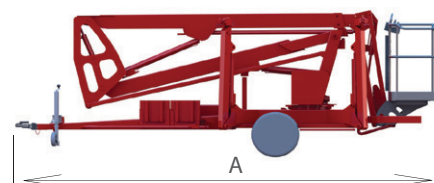
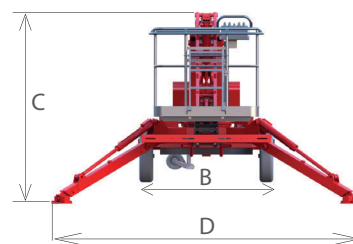

www.instant.no

INSTANT

Norway

Tel.: +47 23 19 11 00
info@instant.no

Lithuania

Tel.: +370 5 233 1096
info@instant.lt

Latvia

Tel.: +371 263 58 152
info@instantlatvija.lv

Estonia

Tel.: +372 680 76 33
info@instant.ee